

No ROHS hazardous material

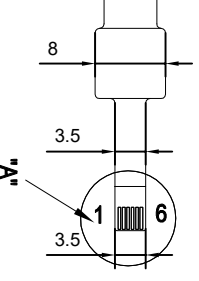

 Cover lens printing area :
Black

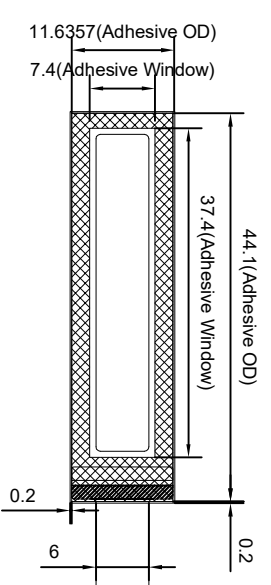
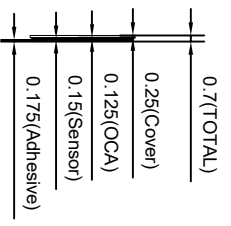
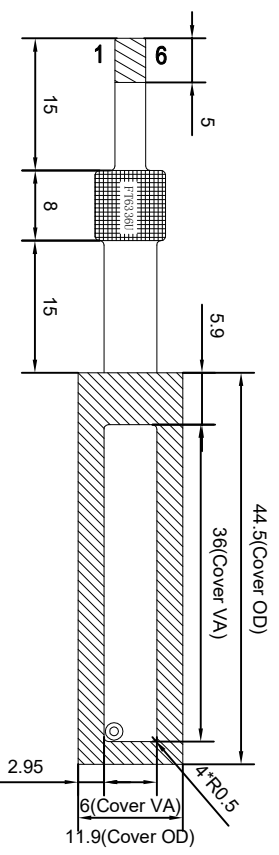
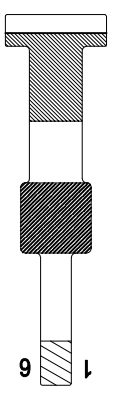

 FOAM Adhesive area:
3M300 (9495)=0.175mm

 Flexible processing area

 FPC component area:
Height ≤ 1.3mm

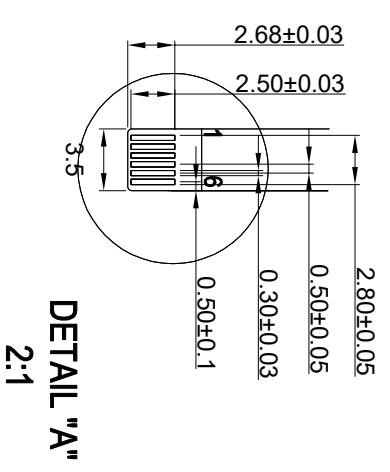

Front view

Side view

Back view

Technical parameters

	TP	PIN.
1. Interfaces:	I2C	VCC(3.3V)
2. Structure :	P+F	RST(3.3V)
3. IC solutions:	FT6336U	INT(3.3V)
4. Impact resistance:	√	SCL(3.3V)
5. Touch points:	1points	SDA(3.3V)
6. Power supply:	3.3V	GND
7. Humidity range:	45~85%RH	
8. Transmittance:	≥70%	
9. Surface hardness:	≥3H	
10. Operate :	-10°C~+60°C, ≤85%RH	
11. Storage :	-20°C~+70°C, ≤85%RH	
12. Unmarked dimension tolerance	as±0.2	



杭州宏梟科技有限公司
GraHowlet Technology CO., Ltd

Model	view direction	Unit
HX0131801		MM
Version	Designer	Date
V0.0	LU0	2018-10-23
Customer	Approved	Date
		Proportion
		1:1